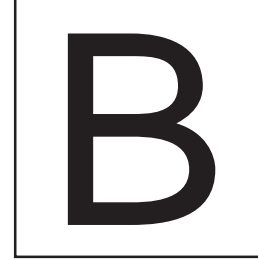

DO NOT OPEN THIS TEST BOOKLET UNTIL YOU ARE ASKED TO DO SO

T.B.C. :

TEST BOOKLET SERIES

Serial

**TEST BOOKLET
GENERAL STUDIES**



Time allowed : Two Hours

Maximum Marks : 150

INSTRUCTIONS

1. IMMEDIATELY AFTER THE COMMENCEMENT OF THE EXAMINATION, YOU SHOULD CHECK THAT THIS BOOKLET **DOES NOT** HAVE ANY UNPRINTED OR TORN OR MISSING PAGES OR ITEMS ETC. IF SO, GET IT REPLACED BY A COMPLETE TEST BOOKLET.
2. ENCODE CLEARLY THE TEST BOOKLET SERIES **A, B, C OR D** AS THE CASE MAY BE IN THE APPROPRIATE PLACE IN THE ANSWER SHEET.
3. You have to enter your Roll Number on the Test Booklet in the Box provided alongside. **DO NOT** write *anything else* on the Test Booklet.
4. This Test Booklet contains **150 items** (questions). Each item is printed both in Hindi and English. Each item comprises four responses (answers). You will select the response which you want to mark on the Answer Sheet. In case you feel that there is more than one correct response, mark the response which you consider the best. In any case, choose **ONLY ONE** response for each item.
5. You have to mark all your responses **ONLY** on the separate Answer Sheet provided. See directions in the Answer Sheet.
6. All items carry equal marks. Attempt **ALL** items. Your total marks will depend **only** on the number of *correct* responses marked by you in the Answer Sheet.
7. Before you proceed to mark in the Answer Sheet the response to various items in the Test Booklet, you have to fill in some particulars in the Answer Sheet as per instructions sent to you with your Admission Certificate.
8. After you have completed filling in all your responses on the Answer Sheet and the examination has concluded, you should hand over to the invigilator **only the Answer Sheet**. You are permitted to take away with you the Test Booklet and rough sheets issued to you.

DO NOT OPEN THIS TEST BOOKLET UNTIL YOU ARE ASKED TO DO SO

ध्यान दें : अनुदेशों का हिन्दी रूपान्तर इस पुस्तिका के पिछले पृष्ठ पर छपा है।

QUESTION PAPER 1999

1. From the balance sheet of a company, it is possible to
 - (a) judge the extent of profitability of the company
 - (b) assess the profitability and size of the company
 - (c) determine the size and composition of the assets and liabilities of the company
 - (d) determine the market share, debts and assets of the company
2. In eye donation, which one of the following parts of a donor's eye is utilised?

(a) Iris	(b) Lens
(c) Cornea	(d) Retina
3. If it is 10.00 am IST, then what would be the local time at Shillong on 92°E longitude?

(a) 9.38 am	(b) 10.38 am
(c) 10.22 am	(d) 9.22 am
4. In the sequence of numbers 5, 8, 13, X, 34, 55, 89,... the value of X is

(a) 20	(b) 21
(c) 23	(d) 29
5. Match the hormones in List I with items in List II and select the correct answer using codes given below the lists.

List I	List II
(a) Adrenalin	1. Anger, fear, danger
(b) Estrogen	2. Attracting partners through sense of smell
(c) Insulin	3. Females
(d) Pheromones	4. Glucose

Codes:

	A	B	C	D
(a)	3	1	4	2
(b)	1	3	2	4
(c)	1	3	4	2
(d)	3	1	2	4
6. In the new Panchayati Raj Bill enacted in 1993, there are several fresh provisions deviating from the past. Which one of the following is *not* one such provision?
 - (a) A number of added responsibilities in the area of agriculture, rural development, primary education and social forestry among others
 - (b) Elections being made mandatory for all posts at the time they are due
 - (c) A statutory representation for women in the panchayats, up to a third of the strength
 - (d) Regular remuneration to the panchayat members, so as to ensure their punctuality and accountability
7. Neem tree has acquired industrial importance as a source of
 - (a) biopesticide and antifertility compound
 - (b) antifertility compound, biofertiliser and anticancer drug
 - (c) biofertiliser, biopesticide and antifertility compound
 - (d) anticancer drug, biopesticide and biofertiliser
8. On another planet, the local terminology for earth, water, light, air and sky, are 'sky', 'light', 'air', 'water' and 'earth' respectively. If someone is thirsty there, what would he drink?

(a) Sky	(b) Water
(c) Air	(d) Light
9. Consider the following statements:
An amendment to the Constitution of India can be initiated by the

(1) Lok Sabha	(2) Rajya Sabha
(3) State Legislatures	(4) President

Which of the above statements is/are correct?

(a) 1 alone	(b) 1, 2 and 3
(c) 2, 3 and 4	(d) 1 and 2
10. The first venture of Gandhi in all-India politics was the
 - (a) Non-Cooperation Movement
 - (b) Rowlatt Satyagraha
 - (c) Champaran Movement
 - (d) Dandi March
11. Match List I (drugs/chemicals) with List II (their uses) and select the correct answer using the codes given below the lists:

List I	List II
(A) Atropine	1. Local anaesthesia
(B) Ether	2. Heart trouble
(C) Nitroglycerine	3. Dilatation of pupil
(D) Pyrethrin	4. Mosquito control

Codes:

	A	B	C	D
(a)	1	3	2	4
(b)	1	3	4	2
(c)	3	1	4	2
(d)	3	1	2	4
12. Which one of the following scholars suggests the earth's origin from gases and dust particles?

(a) James Jeans	(b) H Alfven
(c) F Hoyle	(d) O Schmidt
13. In a business concern, there are four functions, namely, Production (PR), finance (FN), Personnel (PS) and Marketing (MK). The Customer (C) may also play a role in the prosperity of the concern. Match List I with List II and select the correct answer using the codes given below the lists.

List I

Pie Diagram



List II

Statement

1. Customer is the controlling factor
2. Marketing is an integrating factor while customer is the controlling factor
3. Marketing is the controlling factor
4. Marketing is more important than others
5. Marketing is as equal a function as the others

Codes:

	A	B	C	D
(a)	4	3	1	2
(b)	5	4	1	2
(c)	4	3	2	5
(d)	5	4	2	1

14. The term 'Aryan' denotes
 - (a) an ethnic group
 - (b) a nomadic people
 - (c) a speech group
 - (d) a superior race
15. Match List I (Naturally occurring substances) with List II (Elements) and select the correct answer using the codes below the lists.

List I

- (a) Diamond
- (b) Marble
- (c) Sand
- (d) Ruby

List II

1. Calcium
2. Silicon
3. Aluminium
4. Carbon

Codes:

	A	B	C	D
(a)	3	1	2	4
(b)	4	2	1	3
(c)	2	1	3	4
(d)	4	1	2	3

16. Match List I with List II and select the correct answer using the codes given below the list.

List I

(Volcanic mountain)

- A. Mt Rainier
- B. Etna
- C. Paricutin
- D. Taal

List II

(Country)

1. Italy
2. Mexico
3. Philippines
4. USA

Codes:

	A	B	C	D
(a)	4	2	1	3
(b)	4	1	2	3
(c)	2	1	4	3
(d)	4	3	2	1

17. In the given map, which one of the following pairs of ocean currents is shown?



- (a) Benguela and Falkland
- (b) Canary and Humboldt
- (c) Agulhas and Guinea
- (d) Benguela and Guinea

18. Which of the following statements regarding the levying, collecting and distribution of Income Tax is correct?
 - (a) The Union levies, collects and distributes the proceeds of income tax between itself and the states
 - (b) The Union levies, collects the tax but all the proceeds of income tax to itself
 - (c) The Union levies and collects the tax but all the proceeds are distributed among the states
 - (d) Only the surcharge levied on income tax is shared between the union and the states
19. The Congress policy of pray and petition ultimately came to an end under the guidance of
 - (a) Aurobindo Ghosh
 - (b) Bal Gagadhar Tilak
 - (c) Lala Lajpat Rai
 - (d) Mahatma Gandhi
20. Match List I (Quantity) with List II (Units) and select the correct answer using the codes given below the lists.

List I

- A. High speed
- B. Wavelength
- C. Pressure
- D. Energy

List II

1. Mach
2. Angstrom
3. Pascal
4. Joule

Codes:

	A	B	C	D
(a)	2	1	3	4
(b)	1	2	4	3
(c)	1	2	3	4
(d)	2	1	4	3

21. The Ravva offshore block, with great potential for oil, is located in
 - (a) Krishna-Godavari basin
 - (b) Cauvery basin
 - (c) Mahanadi basin
 - (d) Palar-Pennar basin

22. Tourism industry in India is quite small compared to many other countries in terms of India's potential and size. Which one of the following statements is correct in this regard?
- (a) Distances in India are too far apart and its luxury hotels are too expensive for western tourists
 (b) For most of the months India is too hot for western tourists to feel comfortable
 (c) Most of the picturesque resorts in India such as in the North-East and Kashmir are, for all practical purposes, out of bounds
 (d) In India, the infrastructure required for attracting tourists is inadequate
23. In a code language, 'SOLID' is written as 'WPSLPIMFHA'. What does the code word 'ATEXXQIBVO' refer to?
- (a) EAGER (b) WAFER
 (c) WAGER (d) WATER
24. Which one of the following pairs is not correctly matched?
- (a) Jahangir : Willaim Hawkins
 (b) Akbar : Sir Thomas Roe
 (c) Shahjahan : Travernier
 (d) Aurangzeb : Manucci
25. Consider the following temperature and rainfall data:

Month	Temperature °C	Rainfall cm
January	6.7	14.0
February	6.7	13.2
March	7.2	11.4
April	8.9	9.4
May	11.1	8.1
June	13.9	8.1
July	15.0	9.6
August	15.0	12.2
September	13.9	10.4
October	11.1	14.4
November	8.9	14.0
December	7.8	16.8

The climate to which this data pertains is

- (a) St Lawrence type (b) China type
 (c) West European type (d) Mediterranean Type
26. Match List I with List II and select the correct answer using the codes given below the lists.
- | | |
|----------------------------|------------------------------|
| List I
(Persons) | List II
(Journals) |
| (a) Shyamji Krishna Varma | 1. <i>Bande Mataram</i> |
| (b) Madame Bhikaji Cama | 2. <i>Indian Sociologist</i> |
| (c) Annie Besant | 3. <i>The Talwar</i> |
| (d) Aurobindo Ghosh | 4. <i>Commonweal</i> |
- Codes:
- | | | | |
|-------|---|---|---|
| A | B | C | D |
| (a) 2 | 3 | 4 | 1 |
| (b) 3 | 2 | 1 | 4 |
| (c) 2 | 3 | 1 | 4 |
| (d) 3 | 2 | 4 | 1 |
27. In a group of five people, K, L and M are ambitious, M, N and R are honest, L, M and N are intelligent and K, N and R are industrious. Among these, neither industries
- (a) K alone (b) L and R
 (c) M and N (d) none in the group
28. Barium in a suitable form is administered to patients before an X-ray examination of the stomach, because
- (a) barium allows X-rays to pass through the stomach on account of its transparency to X-rays examination
 (b) barium compound, like magnesium sulphate helps in cleaning the stomach before X-ray examination
 (c) barium is a good absorber of X-rays and this helps the stomach to appear clearly in contrast with the other regions in the picture
 (d) barium salts are white in colour and this helps the stomach to appear clearly in contrast with other regions in the picture
29. The *minimum* land area recommended for forest cover to maintain proper ecological balance in India is
- (a) 25% (b) 33%
 (c) 43% (d) 53%
30. A man is standing on the 8 m long shadow of a 6 m long pole. If the length of his shadow is 2.4 m, what is the height of the man?
- (a) 1.4 m (b) 1.6 m
 (c) 1.8 m (d) 2.0 m
31. If the angles of a triangle are in the ratio of 4 : 3 : 2 then the triangle
- (a) is obtuse
 (b) has one angle greater than 80°
 (c) is a right triangle
 (d) is acute
32. From the third century AD when the Hun invasion ended the Roman Empire, the Indian merchants relied more and more in the
- (a) African trade
 (b) West-European trade
 (c) South-East Asian trade
 (d) Middle-Eastern trade
33. Endoscopy, a technique used to explore the stomach or other parts of the body, is based on the phenomenon of
- (a) total internal reflection (b) interference
 (c) diffraction (d) polarisation
34. The planning process in the industrial sector in India has assumed a relatively less important position in the nineties as compared to that in the earlier period. Which one of the following is *not* true in this regard?
- (a) With the advent of liberalisation, industrial investments/developments have largely been placed within the domain of private and multinational sectors
 (b) With markets assuming a central place, the role of central planning in many sectors has been rendered redundant

- (c) The focus of planning has shifted to sectors like human resource development, infrastructure, population control and welfare
 (d) The nation's priorities have shifted away from industrial development to rural development
35. Strips of two metals A and B are firmly joined together as shown in the figure.

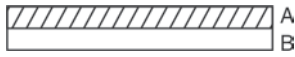

On heating, A expands more than B does. If this joined strip is heated, then it will appear as

- (a) (b) (c) (d)

36. Match the cities labelled as A, B, C and D in the given map with the names of cities and select the correct answer using the codes given below the names of cities.



Name of Cities

1. Darwin 2. Kuala Lumpur
 2. Lagos 4. Nairobi
 5. Singapore

Codes:

	A	B	C	D
(a)	1	2	4	3
(b)	2	1	4	3
(c)	1	4	5	2
(d)	4	3	5	2

37. The first feature film (talkie) to be produced in India was
 (a) Hatimtai (b) Alam Ara
 (b) Pundalik (c) Raja Harishchandra
38. Which one of the following agricultural practices is ecofriendly?

- (a) Organic farming
 (b) Shifting cultivation
 (c) Cultivation of high yielding varieties
 (d) Growing plants in glass-houses

39. If $X + 2Y = 2X + Y$, then X^2/Y^2 is equal to
 (a) 0 (b) 1
 (c) 2 (d) 4
40. The following persons came to India at one time or another
 1. Fa-Hien 2. I-Tsing
 3. Megasthenese 4. Hieun-Tsang
 The correct chronological sequence of their visits is
 (a) 3, 1, 2, 4 (b) 3, 1, 4, 2
 (c) 1, 3, 2, 4 (d) 1, 3, 4, 2
41. The farmers are provided credit from a number of sources for their short-and long-term needs. The main sources of credit to the farmers include
 (a) the Primary Agricultural Cooperative Societies, commercial banks, RRBs and private moneylenders
 (b) the NABARD, RBI, commercial banks and private moneylenders
 (c) the District Central Cooperative Banks (DCCB), the lead banks, IRDP and JRY
 (d) he Large Scale Multi-Purpose Adivasis Programme, DCCB, IFFCO and commercial banks
42. Which one of the countries labelled as 1, 2, 3 and 4 on the given map was granted membership of G-15 in its VII Summit at Kula Lumpur?



- (a) 1 (b) 2
 (c) 3 (d) 4

43. Which one of the following statements is not true of the Konkan Railway?
 (a) The total length is about 760 km
 (b) It runs through the states of Karnataka, Goa, Maharashtra and Kerala
 (c) It is the only rail route that cuts across the Western Ghats
 (d) The Konkan Railway Construction Company which came into being raised money through Public Issues
44. The product lifecycle from inception to demise is shown in the graph. Match List I with List II and select the correct answer the codes given below the lists.

List I
(Stage)

- (a) Product Development
- (b) Maturity
- (c) Growth
- (d) Introduction

List II
(Zone)

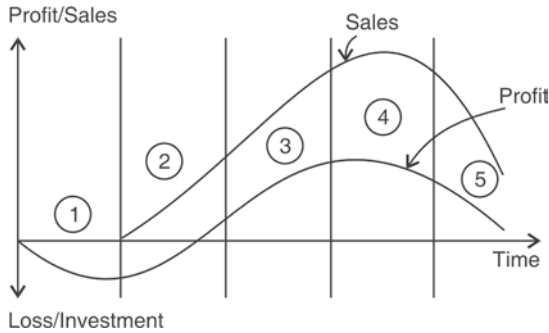

Codes:

- | | | | | |
|-----|---|---|---|---|
| | A | B | C | D |
| (a) | 1 | 4 | 2 | 3 |
| (b) | 1 | 4 | 3 | 2 |
| (c) | 4 | 1 | 2 | 3 |
| (d) | 4 | 1 | 3 | 2 |

45. Which one of the following is a useful functional association between fungi and the roots of higher plants?
- (a) Biofertiliser
 - (b) Coralloid root
 - (c) Lichen
 - (d) Mycorrhiza
46. The physical regions marked as 1, 2, 3 and 4 and on the given map are respectively

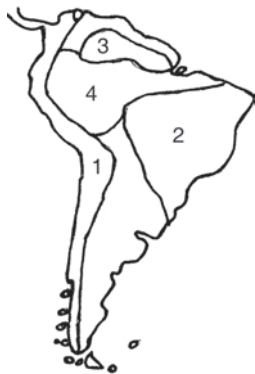

- (a) Andes, Brazilian Shield, Guyana Highlands and Amazon Basin
- (b) Andes, Guyana Highlands, Brazilian Shield and Amazon Basin
- (c) Amazon Basin, Guyana Highlands, Brazilian Shield and Andes
- (d) Guyana Highlands, Brazilian Shield, Andes and Amazon Basin

47. The given figure shows a portion of Southern India. The proposed site (Koodankulam) for the construction of two 1000 MW nuclear power plants has been labelled in the map as

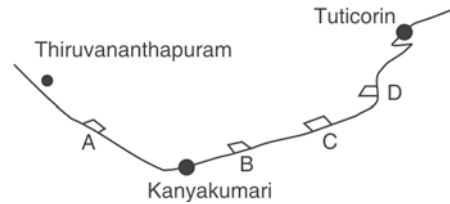

- (a) A
- (b) B
- (c) C
- (d) D

48. At a given time, two players are standing on a playfield. The cartesian coordinates of their locations are (20, 60) and (-40, -20) units. What is the distance between the players?
- (a) 60 units
 - (b) 80 units
 - (c) 100 units
 - (d) 140 units
49. 'Abinava Bharat', a secret society of revolutionaries, was organised by
- (a) Khudiram Bose
 - (b) V D Savarkar
 - (c) Prafulla Chaki
 - (d) Bhagat Singh
50. Which one of the following types of coal contains a higher percentage of carbon than the rest?
- (a) Bituminous coal
 - (b) Lignite
 - (c) Peat
 - (d) Anthracite
51. Match List I with List II and select the correct answer using the codes given below the lists

List I
(Resorts)

- A. Chakrata
- B. Haflong
- C. Kalimpong
- D. Kufri

List II
(States)

- 1. Assam
- 2. West Bengal
- 3. Uttar Pradesh
- 4. Himachal Pradesh

Codes:

- | | | | | |
|-----|---|---|---|---|
| | A | B | C | D |
| (a) | 1 | 3 | 2 | 4 |
| (b) | 3 | 1 | 4 | 2 |
| (c) | 3 | 1 | 2 | 4 |
| (d) | 1 | 3 | 4 | 2 |

52. Which one of the following was initially the most powerful city state of India in the 6th century BC?
- (a) Gandahar
 - (b) Kamboj
 - (c) Kashi
 - (d) Magadha
53. In the given figure, the site of the Tehri Dam has been labelled as

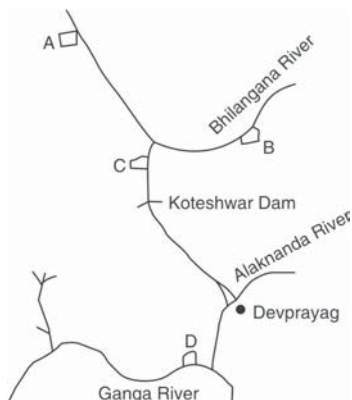

- (a) A (b) B
(c) C (d) D
54. Which one of the following statements is *not* correct?
Dinar/ New Dinar is the currency of
(a) Sudan (b) Yugoslavia (c) UAE (d) Tunisia
55. The language spoken by the largest number of people in the world is
(a) Hindi (b) English
(c) Mandarin (d) Spanish
56. "It made its proposals in May. It still wanted a united India. There was to be a Federal Union composed of British provinces."
The above quotation is related to
(a) Simon Commission (b) Gandhi-Irwin Pact
(c) Cripps Mission (d) Cabinet Mission
57. The Governor-General who followed a spirited "Forward" policy towards Afghanistan was
(a) Minto (b) Dufferin (c) Elgin (d) Lytton
58. In order to win the Grand Slam in Tennis, a player must win which one of the following groups of tournaments?
(a) Australian Open, Wimbledon, French Open, US Open
(b) Wimbledon, French Open, US Open
(c) Wimbledon, French Open, Paegas Czech Open, US Open
(d) Davis Cup, Wimbledon, French Open
59. Which one of the following legislations does *not* deal with the protection of environment?
(a) The Water (Cess) Act, 1977
(b) The Forest (Conservation) Act, 1980
(c) The Public Liability Insurance Act, 1991
(d) The Port Laws Amendment Act, 1997
60. The Indo-Greek kingdom set up in north Afghanistan in the beginning of the second century BC was
(a) Bacteria (b) Scythia
(c) Zedrasia (d) Aria
61. Match List I with List II and select the correct answer using the codes given below the lists.

List I

A. WTO

List II

1. Provides loans to address short-term balance of payment problems

- B. IDA
C. IMF
D. IBRD
2. Multilateral trade negotiation body
3. Sanction of soft loans
4. Facilitating lending and borrowing for reconstruction and development

Codes:

	A	B	C	D
(a)	2	3	4	1
(b)	2	3	1	4
(c)	3	2	4	1
(d)	3	2	1	4

62. At a time when empires in Europe were crumbling before the might of Napolen, which one of the following Governors-General kept the British flag flying high in India?
(a) Warren Hastings (b) Loard Cornwallis
(c) Lord Wellesley (d) Lord Hastings
63. Match the areas shown A, B, C and D on the given map with the largest religious minorities. Select the correct answer using the codes given below the list of minorities



Largest religious Minorities

1. Buddhists
2. Christians
3. Jains
4. Muslims
5. Sikhs

Codes:

	A	B	C	D
(a)	5	1	3	2
(b)	4	3	2	1
(c)	5	3	1	2
(d)	4	2	1	3

64. Amar, Akbar and Anthony are friends, being looked after by a matron Farah. Amar weighs 50% more than Akbar and Anthony weighs 25% less than Amar. Farah weighs a third of the combines weight of the three boys. All four together weigh 232 kg. The correct arrangements of the persons in the ascending order of their weighs is

- (a) Anthony, Akbar, Farah, Amar
 (b) Anthony, Akbar, Amar, Farah
 (c) Akbar, Anthony, Amar, Farah
 (d) Akbar, Anthony, Farah, Amar
65. Which Indian nationalist leader looked upon a war between Germany and Britain as a god-sent opportunity which would enable Indians to exploit the situation to their advantage?
 (a) C Rajagopalachari (b) M A Jinnah
 (c) Subhash Chandra Bose (d) Jawaharlal Nehru
66. As per 1991 census, which one of the following groups of union territories had the highest literacy rate?
 (a) Chandigrah and Dadra and Nagar Haveli
 (b) Delhi and Andaman and Nicobar Islands
 (c) Andaman and Nicobar Islands and Pondicherry
 (d) Pondicherry and Delhi
67. In the rough outline map of a part of Jammu and Kashmir shown in the figure, places marked A, B, C and D represent respectively

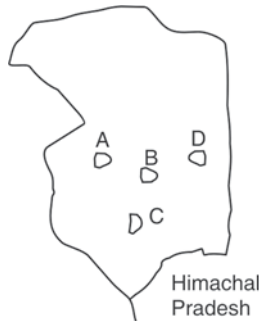

- (a) Anantnag, Baramula, Srinagar and Kargil
 (b) Baramula, Srinagar, Kargil and Anantnag
 (c) Baramula, Srinagar, Anantnag and Kargil
 (d) Srinagar, Baramula, Kargil and Anantnag
68. Which one of the following Indian leaders was dismissed by the British from the Indian Civil Service?
 (a) Satyendranath Tagore (b) Surendranath Banerji
 (c) R C Dutt (d) Subhash Chandra Bose
69. Match List I and List II and select the correct answer using the codes given below the lists.

List I (Writers)	List II (Books)
A. Sashi Tharoor	1. <i>Clear Light of Day</i>
B. Amitav Ghosh	2. <i>Circle of Reason</i>
C. Anita Desai	3. <i>Love and Longing in Bombay</i>
D. Vikram Chandra	4. <i>Show Business</i>

Codes:

- | A | B | C | D |
|-------|---|---|---|
| (a) 4 | 2 | 1 | 3 |

- | | | | |
|-------|---|---|---|
| (b) 4 | 2 | 3 | 1 |
| (c) 2 | 4 | 1 | 3 |
| (4) 2 | 4 | 3 | 1 |

70. Match List I and List II and select the correct answer using the codes given below the lists.

List I (Rivers)	List II (Dams)
A. Cauvery	1. Alamatti
B. Krishna	2. Mettur
C. Narmada	3. Gandhi Sagar
D. Chambal	4. Sardar Sarovar

Codes:

- | A | B | C | D |
|-------|---|---|---|
| (a) 1 | 4 | 2 | 3 |
| (b) 2 | 1 | 4 | 3 |
| (c) 2 | 1 | 3 | 4 |
| (d) 1 | 3 | 4 | 2 |

71. Match List I and List II and select the correct answer using the codes given below the lists.

List I (Books)	List II (Authors)
A. <i>The First Indian War of Independence</i>	1. Rabindranath Tagore
B. <i>Anand Math</i>	2. Sri Aurobindo
C. <i>Life Divine</i>	3. Bankim Chandra Chatterji
D. <i>Sadhana</i>	4. Vinayak Damodar Savarkar

Codes:

- | A | B | C | D |
|-------|---|---|---|
| (a) 4 | 3 | 2 | 1 |
| (b) 3 | 4 | 1 | 2 |
| (c) 4 | 3 | 1 | 2 |
| (d) 3 | 4 | 2 | 1 |

72. Consider the following events:

- | | |
|------------------|-------------------------|
| 1. Indigo Revolt | 2. Santhal Rebellion |
| 3. Deccan Riot | 4. Mutiny of the Sepoys |

The correct chronological sequence of these events is

- | | |
|----------------|----------------|
| (a) 4, 2, 1, 3 | (b) 4, 2, 3, 1 |
| (c) 2, 4, 3, 1 | (d) 2, 4, 1, 3 |

73. Match List I and List II and select the correct answer using the codes given below the lists:

List I (Year)	List II (Event)
(a) 1775	1. First Anglo-Burmese War
(b) 1780	2. First Anglo-Afghan War
(c) 1824	3. First Anglo-Maratha War
(d) 1838	4. Second Anglo-Mysore War

Codes:

- | A | B | C | D |
|-------|---|---|---|
| (a) 4 | 3 | 2 | 1 |
| (b) 4 | 3 | 1 | 2 |
| (c) 3 | 4 | 1 | 2 |
| (d) 3 | 4 | 2 | 1 |

74. Since 1980, the share of the tertiary sector in the total GDP of India has
- shown an increasing trend
 - shown a decreasing trend
 - remained constant
 - been fluctuating
75. Which one of the following areas marked as A, B, C and D in the given figure of the cyclone, witness heavy torrential short-duration rainfall accompanied by thunderstorms?

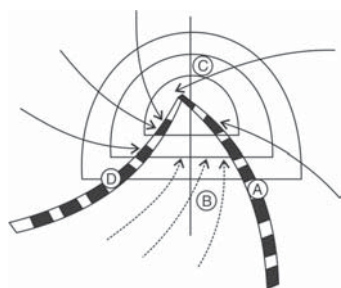

- A
 - B
 - C
 - D
76. One consistent feature found in the history of southern India was the growth of small regional kingdoms rather than large empires because of
- The absence of minerals like iron
 - too many divisions in the social structure
 - the absence of vast areas of fertile land
 - the scarcity of manpower
77. Consider the following statements:
An ordinary light bulb has a rather short life because he
- filament wire is not uniform
 - bulb cannot be evacuated completely
 - wires supporting the filament melt at high temperatures
- Which of the above statements are correct?
- 1 and 3
 - 2 and 3
 - 1 and 2
 - 1, 2 and 3
78. The Constitution of India recognises
- only religious minorities
 - only linguistic minorities
 - religious and linguistic minorities
 - religious, linguistic and ethnic minorities
79. The king was freed from his people and they from their king.' On whose death Badauni comment thus?
- Balban
 - Ala-ud-din Khalji
 - Muhammad-bin-Tughlak
 - Feroze Shah Tughlak
80. A ship sailing from the eastern extremity of the Aleutian Islands to Dutch harbour crosses 180° meridian at 23.30 hrs on January 1, 1999. What time and date will be recorded by the captain of the ship in his diary after one-hour journey from the point of crossing of the meridian?
- January 1, 0030 hrs
 - January 2, 0030 hrs
 - January 3, 0030 hrs
 - January 4, 0030 hrs

81. Persons below the poverty line in India are classified as such based on whether
- they are entitled to a minimum prescribed food basket
 - they get work a prescribed minimum number of days in a year
 - they belong to agricultural labourer household and the scheduled caste/tribe social group
 - their daily wages fall below the prescribed minimum wages
82. Consider the following statements:
Regional disparities in India are high and have been rising in recent years because
- there is persistent investment over time only in select locales
 - some areas are agro-climatically less conducive to development
 - some areas continue to face little or no agrarian transformation and the consequent lack of social and economic opportunities
 - some areas have faced continuous political instability
- Which of the above statements are correct?
- 1, 2 and 3
 - 1, 2 and 4
 - 1, 3 and 4
 - 2, 3, and 4
83. Indian farmers are unhappy over the introduction of "Terminator Seed Technology" because the seeds produced by this technology are expected to
- show poor germination
 - form low-yielding plants despite the high quality
 - give rise to sexually sterile plants
 - give rise to plants incapable of forming viable seeds
84. Consider the following statements about the recent amendments to the Election Law by the Representation of the People (Amendment) Act, 1996:
- Any conviction for the offence of insulting the Indian National flag or the Constitution of India shall entail disqualification for contesting elections to Parliament and state legislatures for six years from the date of conviction
 - There is an increase in the security deposit which a candidate has to make to contest the election to the Lok Sabha
 - A candidate cannot now stand for election from more than one parliamentary constituency
 - No election will now be countermanded on the death of a contesting candidate
- Which of the above statements are correct?
- 2 and 3
 - 1, 2 and 4
 - 1 and 3
 - 1, 2, 3 and 4
85. The average speed of a train in the onward journey is 25% more than that of the return journey. The train halts for one hour on reaching the destination. The total taken for the complete to and fro journey is 17 hours covering a distance of 800 km. The speed of the train in the onward journey is
- 45 km per hour
 - 47.06 km per hour
 - 50 km per hour
 - 56.25 km per hour

86. Consider the following statements:
The striking feature of the Jama Masjid in Kashmir completed by Zain-ul-Abidin include(s)
1. turret
 2. similarity with Buddhist pagodas
 3. Persian style
- Which of the above statements is/are correct?
- (a) 1 alone (b) 1, 2 and 3
(c) 2 and 3 (d) 1 and 3
87. Consider the following statements regarding a motor car battery:
1. The voltage is usually 12 V
 2. Electrolyte used is hydrochloric acid
 3. Electrodes are lead and copper
 4. Capacity is expressed in ampere-hour
- Which one the above statements are correct?
- (a) 1 and 2 (b) 2 and 3
(c) 3 and 4 (d) 1 and 4
88. In a town 25% families own a phone and 15% own a car. 65% families own neither a phone nor a car. 2000 families own both a car and a phone.
- Consider the following statements in this regard
- (a) 10% families own both a car and a phone
 - (b) 35% families own either a car or a phone
 - (c) 40, 000 families live in the town
- Which on the above statements are correct?
- (a) 1 and 2 (b) 1 and 3
(c) 2 and 3 (d) 1, 2 and 3
89. Consider the following statements:
Industrial development in India, to an extent, is constrained by
1. lack of adequate entrepreneurship and leadership in business
 2. lack of savings to invest
 3. lack of technology, skills and infrastructure
 4. limited purchasing power among the larger masses
- Which of the above statements are correct?
- (a) 1, 2 and 3 (b) 1, 3 and 4
(c) 2, 3 and 4 (d) 1, 2 and 4
90. At which one of the following positions shown in the diagram will the height of the ocean tide be maximum?

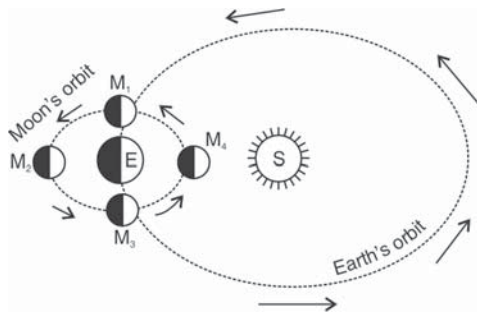

- (a) M_1 (b) M_2
(c) M_3 (d) M_4

91. Which one of the following genetic diseases is sex-linked?
(a) Royal haemophilia (b) Tay-Sachs disease
(c) Cystic fibrosis (d) Hypertension
92. The yield versus fertiliser input is shown in the graph

Consider the following statements based on this graph:

1. Yield rate is zero at B and C
2. There is no yield with no fertiliser inputs
3. The yield is minimum at D
4. The yield is neither minimum nor maximum at C

Which of the above statements are correct?

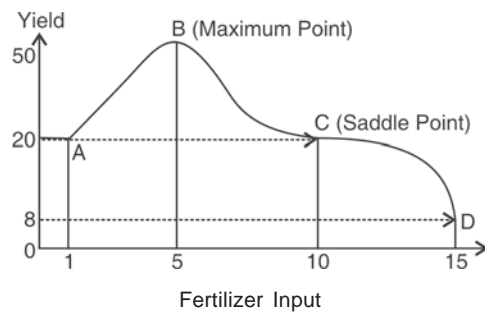

- (a) 1, 2 and 4 (b) 3 and 4
(c) 2 and 3 (d) 1, 3 and 4
93. Among which one of the following sets of social-religious groups in the extent of poverty the highest, as per government statistics for the nineties?
- (a) Muslims in Kerala, Gujarat and AP
 - (b) Tribals in Bihar, Orissa, MP and Maharashtra
 - (c) Scheduled Castes in Punjab, Western UP, northern Rajasthan and Tamil Nadu
 - (d) Christians in Gujarat, Maharashtra and Assam
94. For which one of the following is capillarity *not* the only reason?
- (a) Blotting of ink
 - (b) Rising of underground water
 - (c) Spread of water drop on a cotton cloth
 - (d) Rising of water from the roots of a plant to its foliage
95. Which one of the following statements is correct?
- (a) Kacchativu and Tin Bigha were territories acquired by the Indian Republic from the French
 - (b) Kacchativu and Tin Bigha are territories handed over to Sri Lankan and Bangladeshi sovereignty respectively by the Government of India
 - (c) Kavvativu and Tin Bigha are areas that were annexed by the Chinese in the 1962 Sino-Indian War
 - (d) Kacchativu and Tin Bigha are enclaves which were transferred to India by lease arrangements with Sri Lanka and Pakistan respectively
96. Consider the following statements:
1. If a person looks at a coin which is in a bucket of water, the coin will appear to be closer than it really is

2. If a person under water looks at a coin above the water surface, the coin will appear to be at a higher level than it really is

Which of the above statements is/are correct?

- (a) 1 and 2 (b) 1 alone
(c) 2 alone (d) Neither 1 nor 2

97. The Employment Assurance Scheme envisages financial assistance to rural areas for guaranteeing employment to at least

- (a) 50 per cent of the men and women seeking jobs in rural areas
(b) 50 per cent of the men seeking jobs in rural areas
(c) one man and one woman in a rural family living below the poverty line
(d) one person in a rural landless household living below the poverty line

98. Lathyrism is caused by excessive consumption of

- (a) Kesari dal (b) Mustard oil
(c) Polished rice (d) Mushrooms

99. A company manufacturing air-conditioners has set a monthly target. The target and realised values are shown in the bar chart.

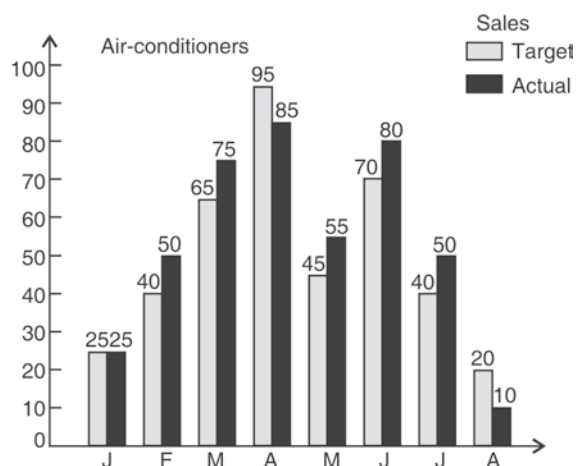

Consider the following statements based on the chart:

- The targeted sales on a monthly basis have been achieved
- The overall target value has been exceeded by 7.5%
- The Sales Department deserves a part on the back

Which of the above statements is/are correct?

- (a) 1 alone (b) 2 alone
(c) 1 and 2 (d) 2 and 3

100. A British citizen staying in India cannot claim Right to

- (a) Freedom to trade and profession
(b) Equality before the law
(c) Protection of life and personal liberty
(d) Freedom of religion

101. Match List I with List II and select the correct answer using the codes given below the lists:

List I
(Timber)

- (a) Cedar
(b) Douglas Fir
(c) Mahogany
(d) Teak

List II
(Country)

1. Myanmar
2. Canada
3. Mexico
4. Honduras

Codes:

- | | A | B | C | D |
|-----|---|---|---|---|
| (a) | 3 | 2 | 1 | 4 |
| (b) | 3 | 2 | 4 | 1 |
| (c) | 2 | 3 | 4 | 1 |
| (d) | 2 | 3 | 1 | 4 |

102. The first writer to use Urdu as the medium of poetic expression was

- (a) Amir Khusru (b) Mirza Ghalib
(c) Bahadur Shah Zafar (d) Faiz

103. Consider the following statements regarding the National Human Rights Commission of India.

- (a) Its chairman must be a retired Chief Justice of India
(b) It has formations in each state as State Human Rights Commission
(c) Its powers are only recommendatory in nature
(d) It is mandatory to appoint a woman as a member of the Commission

Which of the above statements are corrects?

- (a) 1, 2, 3 and 4 (b) 2 and 4
(c) 2 and 3 (d) 1 and 3

104. Match List I with List II and select the correct answer using the codes given below the lists:

List I

- A. Cotton
B. Flax
C. Sugarbeet
D. Jute

List II

- Rainfall 1000–1500 mm; Temperature 40°–60°C
- Rainfall 1500–2000 mm; Temperature 25°–35°C
- Rainfall 600–800 mm; Temperature 5°–18°C
- Rainfall 500–1000 mm; Temperature 18°–22°C
- Rainfall 500–600 mm; Temperature 18°–22°C

Codes:

- | | A | B | C | D |
|-----|---|---|---|---|
| (a) | 1 | 3 | 4 | 2 |
| (b) | 2 | 3 | 5 | 4 |
| (c) | 4 | 5 | 2 | 1 |
| (d) | 4 | 3 | 5 | 2 |

105. The paintings of Abanindranath Tagore are classified as

- (a) realistic (b) socialistic
(c) revivalistic (d) impressionistic

106. Which one of the following port cities in Venezuela has been developed as an oil port?

- (a) Caracas (b) Maracaibo
(c) Maracay (d) Carupano

107. Match List I with List II and select the correct answer using the codes given below the list:

List I	List II
A. Pandit Vishnu Digambar Paluskar	1. Introduced the scheme of Raga classification of Indian music
B. Venkatamahi	2. Proponent of Carnatic music
C. Shyama Shastri	3. Proponent of the Khayal form of Hindustani music
D. Amir Khusru	4. Wrote the music for the song 'Vande Mataram'

Codes:

	A	B	C	D
(a)	4	1	3	2
(b)	4	1	2	3
(c)	1	4	3	2
(d)	1	4	2	3

108. The surface area of a spherical dome-shaped roof of a cylindrical water tank shown in the figure is

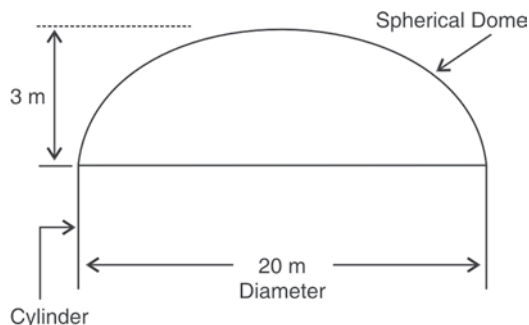

- (a) $60\pi \text{ m}^2$ (b) $109\pi \text{ m}^2$
(c) $120\pi \text{ m}^2$ (d) $300\pi \text{ m}^2$

109. There was no independent development of industries in India during British rule because of the

- (a) absence of heavy industries
(b) scarcity of foreign capital
(c) scarcity of natural resources
(d) preference of the rich to invest in land

110. Consider the following statements:

Small scale industries are, in most cases, not as efficient and competitive as the large scale ones. Yet the government provides preferential treatment and reservations in a range of products to the small firms because small scale industries

1. provide higher employment on a per unit capital deployment basis

2. promote a regional dispersion of industries and economic activities

3. have performed better in export of manufactured products than the large scale ones

4. provide jobs to low-skill workers, who otherwise may not find employment avenues elsewhere

Which of the above statements are correct?

- (a) 1 and 4 (b) 1 and 2
(c) 2 and 3 (d) 3 and 4

111. A hemispherical bowl is filled to the brim with a beverage. The contents of the bowl are transferred into a cylindrical vessel whose radius is 50% more than its height. If the diameter is same for both bowl and cylinder, then the volume of the beverage in the cylindrical vessel will be

- (a) $66\frac{2}{3}\%$ (b) $78\frac{1}{2}\%$

(c) 100%

(d) more than 100% (than is, some liquid will still be left in the bowl)

112. A hunter aims his gun at a point between the eyebrows of a monkey sitting on a branch of a tree. Just as he fires, the monkey jumps down. The bullet will

- (a) hit the monkey at the point aimed
(b) hit the monkey below the point aimed
(c) hit the monkey above the point aimed
(d) miss the monkey altogether

113. The economic crisis in the latter half of 1990s most seriously affected Indonesia, Thailand, Malaysia and South Korea. The cause of the crisis was

- (a) mismanagement of the financial resources and financial sector, in general
(b) the prolonged over-valuation of local currencies vis-a-vis the western currencies
(c) the downswing and recession in the western economies which earlier provided export market to these export oriented countries
(d) None of the above

114. A person of mixed European and Indian blood in Latin America is called a

- (a) Mulatto (b) Mestizo
(c) Meiji (d) Mau mau

115. Match List I with List II and select the correct answer using the codes given below the lists:

List I (Libraries)	List II (Locations)
A. Saraswati Mahal Library	1. Patna
B. Library of Tibetan Work and Archives	2. Dharamsala
C. Raza Library	3. Thanjavur
D. Khuda Baksh Oriental Public Library	4. Rampur

Codes:

	A	B	C	D
(a)	3	2	4	1

- (b) 3 2 1 4
- (c) 2 3 1 4
- (d) 2 3 4 1

116. In an office, the distribution of work hours is as shown in the following table:

No. of staff members	No. of hours worked
5	0 – 19
12	20 – 24
25	25 – 29
40	30 – 34
15	35 – 39
8	40 – 45

Consider the following inferences drawn from the table:

1. The average number of hours worked by a staff member is about 30
2. The percentage of those who worked 35 or more hours is less than 25
3. At least 5 staff members worked more than 44 hours

Which of these inferences is/are valid?

- (a) 1 alone
- (b) 2 alone
- (c) 1 and 2
- (d) 1, 2 and 3

117. When ants bite, they inject

- (a) glacial acetic acid
- (b) methanol
- (c) formic acid
- (d) stearic acid

118. In a factory, quality assurance test is conducted on various samples for a specific characteristic value of the product. The values and the number of samples are as given in the following table:

Characteristic value, X	No of samples
10	3
11	7
12	10
13	15
14	28
15	33
16	24
17	11
18	10
19	6
20	3

Consider the following statements based on the table:

1. The probability that $X \leq 15$ is 0.64
2. The probability that $13 < X \leq 17$ is greater than 0.64
3. The probability that $X = 15$ is less than 0.22

Which of the above statements is/are *not* true?

- (a) 1 alone
- (b) 1 and 2
- (c) 2 and 3
- (d) 1, 2 and 3

119. Transchart is the

- (a) chartering wing of the Ministry of Surface Transport
- (b) container service established by Indian Railways
- (c) training institute of maritime studies and research
- (d) passenger insurance scheme of Indian Railways

120. To Which Lodi Sultan does the given map relate and what town does the site marked A on the map represent?



- (a) Behlol Lodi, Jaunpur
- (b) Sikandar Lodi, Aligarh
- (c) Ibrahim Lodi, Jaunpur
- (d) Ibrahim Lodi, Aligarh

121. “India has the largest population of the Asian X. Today, there are just about 20,000 to 25,000 X in their natural habitat spreading across the evergreen forests, dry thorn forests, swamps and grasslands Their prime habitats are, however, the moist deciduous forests. The X population in India ranges from North-West India where they are found in the forest divisions of Dehradun, Bijnor and Nainital districts of UP to the Western Ghats in the states of Karnataka and Kerala and in Tamil Nadu.

In Central India, their population is distributed in southern Bihar and Orissa. In the East, they are seen in North Bengal, Assam and a few other states”.

The animal ‘X’ referred to in this quotation is

- (a) lion
- (b) elephant
- (c) tiger
- (d) one-horned rhinoceros

122. Which one of the following is the objective of National Renewal Fund?

- (a) To safeguard the interests of workers who may be affected by technological upgradation of industry or closure of sick units
- (b) To develop the core sector of the economy
- (c) For the development of infrastructure such as energy, transport, communications and irrigation
- (d) For human resource development such as full literacy, employment, population control, housing and drinking water

123. Consider the following statements about the European Union:

1. The European Union was known earlier as the European Community
2. The Single European Act (1986) and the Maastricht Treaty were milestones in its formation
3. Citizens European Union countries enjoy dual citizenship
4. Switzerland is a member of the European Union

Which of the above statements are correct?

- (a) 2 and 4 (b) 1 and 3
(c) 3 and 4 (d) 1, 2 and 3

124. The area of an ellipse is twice that of a circle. The major diameter of the ellipse is twice that of the minor diameter. The radius of the circle is
(a) 50% of minor diameter of the ellipse
(b) 50% of major diameter of the ellipse
(c) minor diameter of the ellipse
(d) major diameter of the ellipse
125. Cobalt-60 is commonly used in radiation therapy because it emits
(a) alpha rays (b) beta rays
(c) gamma rays (d) X-rays
126. In which one of the following areas in the given map was there a recent discovery of copper deposits by the Atomic Minerals Divisions of the department of Atomic Energy?

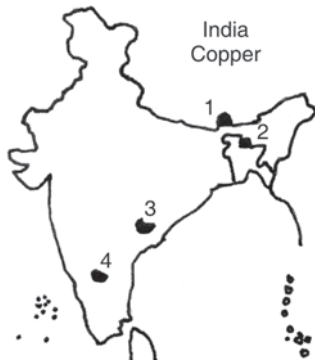

- (a) 1 (b) 2
(c) 3 (d) 4

127. Which one of the following pairs is *not* correctly matched?
(a) Jim Laker : Highest number of wickets in a Cricket Test Match
(b) Brian Lara : Highest score in an innings in Test cricket
(c) Sanath : Highest partnership in an Jayasurya and innings in Test cricket Roshan Mahanama
(d) Suni M. Gavaskar : Highest aggregate of runs in Test cricket
128. The most shortlived of all of Britain's constitutional experiments in India was the
(a) Indian Council Act of 1861
(b) Indian Councils Act of 1892
(c) Indian Councils Act of 1909
(d) Government of India Act of 1919
129. Match List I with List II and select the correct answer using the codes given below the lists:

List I (Industries)	List II (Industrial Centres)
A. Pearl fishing	1. Pune

- B. Automobiles 2. Tuticorin
C. Shipbuilding 3. Pinjore
D. Engineering goods 4. Marmagao

Codes:

	A	B	C	D
(a)	2	1	4	3
(b)	2	1	3	4
(c)	1	2	4	3
(d)	1	2	3	4

130. The first marine sanctuary in India, having within its bounds coral reefs, mollusca, dolphins, tortoises and various kinds of sea birds, has been established in
(a) Sundarbans (b) Chilka Lake
(c) Gulf of Kachchh (d) Lakshadweep
131. Which one of the following pairs of folk dance forms and states in *not* correctly matched?
(a) Korku : Maharashtra
(b) Jhummar : Haryana
(c) Thali : Himachal Pradesh
(d) Mukna : Manipur
132. Low temperatures (Cryogenics) find application in
(a) space travel, surgery and magnetic levitation
(b) surgery, magnetic levitation and telemetry
(c) space travel, surgery and telemetry
(d) space travel, magnetic levitation and telemetry
133. The population growth rate in Kerala is the lowest among major Indian states. Which one of the following is the most widely accepted reason for this?
(a) Kerala has made the highest investment in family planning
(b) Kerala has the highest literacy rate in India
(c) Kerala has invested heavily in promoting literacy and public health and placed high priority on social policies
(d) The population pyramid in Kerala has relatively fewer women in the reproductive age group
134. Which one of the following pairs of states and tribes is *not* correctly matched?
(a) Assam : Miri
(b) Nagaland : Konyak
(c) Arunachal Pradesh : Apatani
(d) Madhya Pradesh : Lambada
135. Which one of the following leaders of the Congress was totally in favour of Cabinet Mission Plan?
(a) Mahatma Gandhi
(b) Jawaharlal Nehru
(c) Sardar Patel
(d) Maulana Abul Kalam Azad
136. In the November 1998 Composite Dialogue Process between India and Pakistan, three contentious issues listed below as 1, 2, and 3 were discussed.
Contentious Issues
1. Disengagement of troops
2. Settlement of boundary dispute
3. Sharing river water



Match the issues with the areas marked in the map as A, B and C and select the correct answer using the codes given below:

Codes:

	A	B	C
(a)	2	1	3
(b)	2	3	1
(c)	1	3	2
(d)	3	2	1

137. Which one of the following statements is *not* correct?

- (a) 'Neel Darpan' was a play based on the exploitation of the indigo farmers
- (b) The author of the play 'Ghashiram Kotwal' is Vijay Tendulkar
- (c) The play 'Navanna' by Nabin Chandra Das was based on the famine of Bengal
- (d) Urdu theatre used to depend heavily on Parsi theatre

138. Consider the following statements:

Glass can be etched or scratched by

- 1. diamond
- 2. hydrofluoric acid
- 3. aquaregia
- 4. conc sulphuric acid

Which of these statements are correct?

- (a) 1 and 4
- (b) 2 and 3
- (c) 1 and 2
- (d) 2 and 4

139. The term "imperial preference" was applied to the

- (a) special privileges on British imports in India
- (b) racial discrimination by the Britishers
- (c) subordination of Indian interest to that of the British
- (d) preference given to British political agents over Indian princes

140. Which one of the following ports handled the north Indian trade during the Gupta period?

- (a) Tamralipti
- (b) Broach
- (c) Kalyan
- (d) Cambray

Directions: The following 10 items consist of two statements, one labelled as 'Assertion A' and the other labelled as 'Reason R'. You are to examine these two statements

carefully and decide of the Assertion A and the Reason R are individually true and if so, whether the Reason is a correct explanation of the Assertion. Select your answers to these items using the codes given below.

Codes:

- (a) Both A and R are true and R is the correct explanation of A
- (b) Both A and R are true but R is not a correct explanation of A
- (c) A is true but R is false
- (d) A is false but R is true

141. Assertion (A) : During the time of Akbar, for every ten cavalymen, the mansabdars had to maintain twenty horses.

Reason (R) : Horses had to be rested while on march and replacements were necessary in times of war.

142. Assertion (A) : Lord Linlithgow described the August Movement of 1942 as the most serious rebellion since Sepoy Mutiny.

Reason (R) : There was massive upsurge of the peasantry in certain areas.

143. Assertion (A) : To dilute sulphuric acid, is added to water and *not* water to acid.

Reason (R) : Specific heat of water is quite large.

144. Assertion (A) : Devaluation of a currency may promote export.

Reason (R) : Price of country's products in the international market may fall due to devaluation.

145. Assertion (A) : Fiscal deficit is greater than budgetary deficit.

Reason (R) : Fiscal deficit is the borrowing from the Reserve Bank of India plus other liabilities of the government to meet its expenditure.

146. Assertion (A) : According to statistics, more female children are born each year than male children in India.

Reason (R) : In India, the death rate of a male child is higher than that of the female child.

147. Assertion (A) : Insect resistant transgenic cotton has been produced by inserting Bt gene.

Reason (R) : The Bt, gene is derived from a bacterium.

148. Assertion (A) : Information technology is fast becoming a very important field of activity in India.

Reason (R) : Software is one of the major exports of the country and India has a very strong base in hardware.

149. Assertion (A) : Chile continues to be an important producer of copper in the world.

Reason (R) : Chile is endowed with the world's largest deposit of porphyry copper.

150. Assertion (A) : Dolly was the first cloned mammal.

Reason (R) : Dolly was produced by *in vitro* fertilisation.

ANSWERS

1. (c)	31. (d)	61. (b)	91. (a)	121. (b)	15. (d)	45. (d)	75. (d)	105. (c)	135. (d)
2. (c)	32. (c)	62. (c)	92. (b)	122. (a)	16. (b)	46. (d)	76. (c)	106. (b)	136. (b)
3. (b)	33. (a)	63. (c)	93. (b)	123. (d)	17. (d)	47. (b)	77. (b)	107. (b)	137. (c)
4. (b)	34. (d)	64. (d)	94. (b)	124. (a)	18. (a)	48. (c)	78. (c)	108. (b)	138. (d)
5. (c)	35. (b)	65. (c)	95. (b)	125. (c)	19. (b)	49. (b)	79. (c)	109. (d)	139. (a)
6. (d)	36. (a)	66. (d)	96. (a)	126. (b)	20. (c)	50. (d)	80. (a)	110. (b)	140. (c)
7. (c)	37. (b)	67. (c)	97. (c)	127. (a)	21. (a)	51. (c)	81. (a)	111. (c)	141. (b)
8. (d)	38. (a)	68. (b)	98. (a)	128. (c)	22. (d)	52. (c)	82. (a)	112. (d)	142. (b)
9. (d)	39. (b)	69. (a)	99. (d)	129. (a)	23. (d)	53. (c)	83. (d)	113. (a)	143. (b)
10. (c)	40. (b)	70. (b)	100. (a)	130. (c)	24. (b)	54. (c)	84. (b)	114. (b)	144. (a)
11. (d)	41. (a)	71. (a)	101. (b)	131. (a)	25. (c)	55. (c)	85. (d)	115. (a)	145. (c)
12. (d)	42. (d)	72. (d)	102. (a)	132. (a)	26. (a)	56. (d)	86. (c)	116. (c)	146. (c)
13. (b)	43. (c)	73. (c)	103. (d)	133. (c)	27. (d)	57. (d)	87. (d)	117. (c)	147. (b)
14. (c)	44. (b)	74. (a)	104. (d)	134. (d)	28. (c)	58. (a)	88. (c)	118. (a)	148. (c)
					29. (b)	59. (d)	89. (c)	119. (a)	149. (c)
					30. (c)	60. (a)	90. (d)	120. (a)	150. (d)